

CDM-1000-0600-1-ACB M1

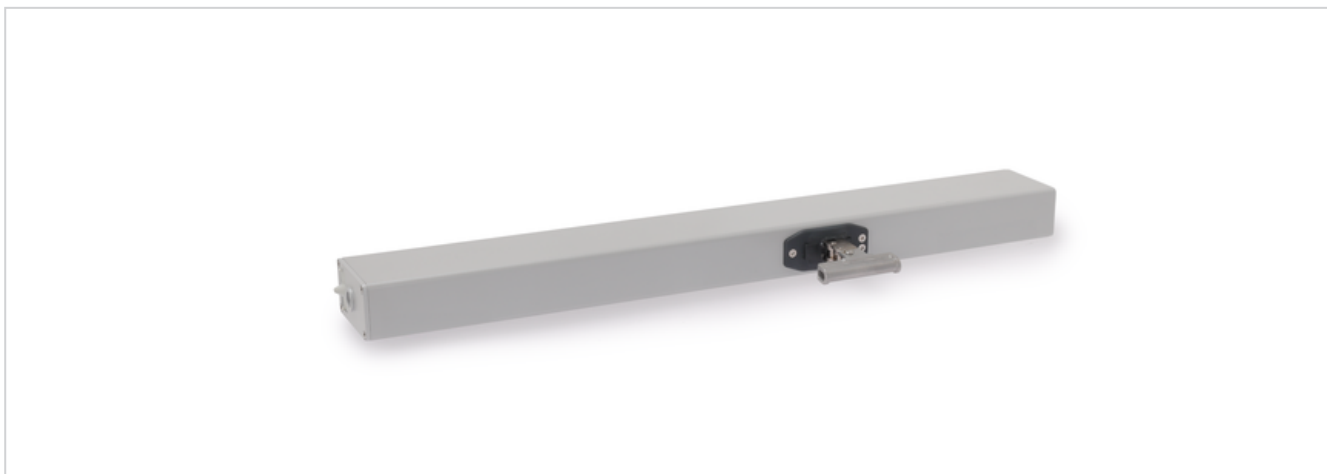

Performance features

- + Can be used for openings for smoke exhaust, D+H Euro SHEV in accordance with EN 12101-2 and for daily ventilation
- + With BSY+ motor and synchronised electronics controlled via microprocessor
- + Option of up to 4 drives in one synchronous group
- + High-speed function (HS) for especially fast opening windows in case of fire (SHEV)
- + Low running noises thanks to the innovative acoustic decoupling of the drive components
- + Special chain stabilisation and centred chain outlet
- + Compact design thanks to triple deflection of the chain
- + Use of a highly efficient, wear-free brushless motor
- + Relief of pressure on window gasket after closing process
- + Programmable drive functions and different drive parameters
- + Time-controlled reversing when an obstacle is detected in the CLOSED direction (active closing edge protection)
- + Integrated ACB (Advanced Communication Bus) bus interface with Modbus RTU protocol
- + The drive is integrated directly via open bus communication through the ACB (Advanced Communication Bus), e.g. in a building management system

Approvals / Certificates

Details of approval on request.



Article also available with the following permissions under other article numbers. Technical data may deviate.



Technical data

CDM-1000-0600-1-ACB M1

Supply	24 V DC / ±15 % / 2 A
Duty cycle	30 % (ON: 3 min. / OFF: 7 min.)
Configuration	Main 1
Force of pressure	1000 N
Tensile force	1000 N
Nominal locking force	3500 N
Service life	> 20000 double strokes
Stroke	600 mm
OPEN running speed	7 mm/s
OPEN running speed - SHEV	11.5 mm/s
CLOSED running speed	5 mm/s
Type of protection	IP 42
Emission sound pressure level	LpA ≤ 45 dB(A)
Temperature range	-15 °C ... +75 °C
Fire resistance	B300 (30 min / 300 °C)
Housing	Aluminium
Surface	Powder-coated
Colour	White aluminium (~ RAL 9006)
Connection	Silicone cable (must be ordered separately)
Dimension A	608 mm
Dimension B	335 mm
W x H x D	608 x 53 x 90 mm
Weight	4.85 kg
Art. No.	26.200.11

Dimensions

All specifications in mm

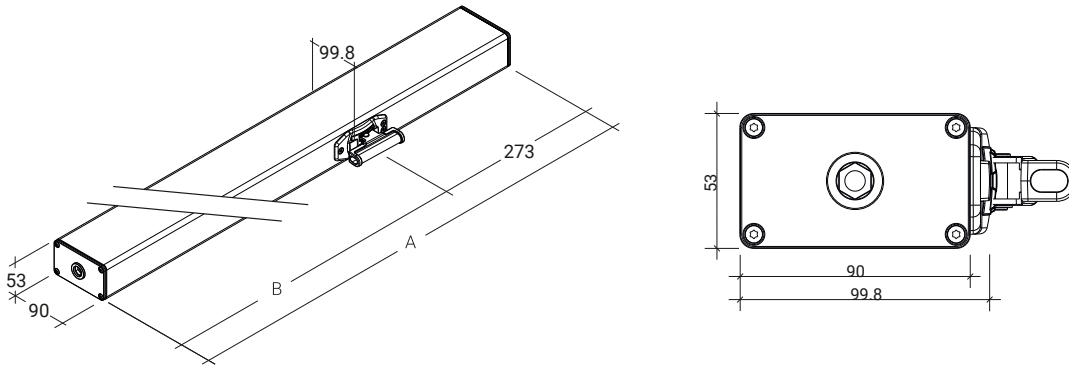

Pressure load diagram

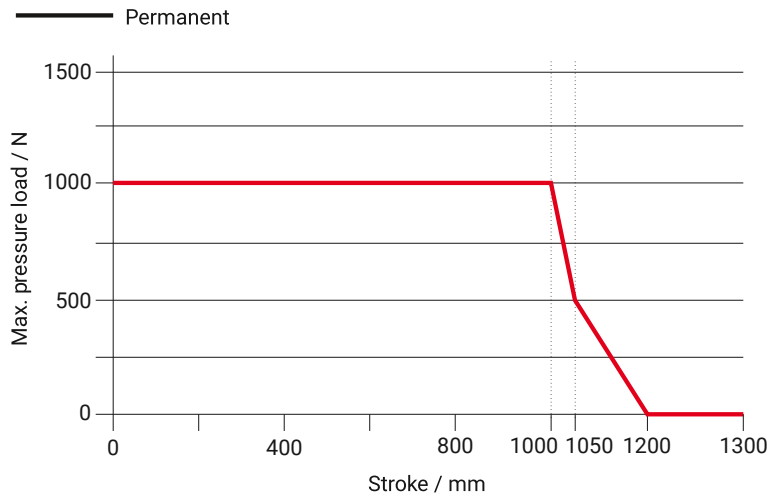

Possible applications

- + Mounted installation
- + Application force
- + Frame mounting
- + Application tension

