

# KA 34/500-K



## Performance features

- + Can be used for openings for smoke exhaust, D+H Euro SHEV in accordance with EN 12101-2 and for daily ventilation
- + With motor electronics controlled via microprocessor
- + Direct control via 230 V AC
- + Special chain stabilisation
- + Relief of pressure on window gasket after closing process
- + Pressure applications up to 700 mm, application tension stroke lengths >1000 mm possible
- + Easy window control via 230 V AC ventilation button
- + Adjustable electronic closing force optimisation
- + Running speed in CLOSED direction decreases to 5 mm/s (passive closing edge protection)
- + Time-controlled reversing when an obstacle is detected in the CLOSED direction (active closing edge protection)

## Approvals / Certificates

Details of approval on request.



5014068.24001

# Technical data

## KA 34/500-K

<b>Supply</b>	230 V AC / +10 % ... -15 % / 50 Hz
<b>Performance</b>	24 W / 40 VA
<b>Duty cycle</b>	30 % (ON: 3 min. / OFF: 7 min.)
<b>Force of pressure</b>	300 N
<b>Tensile force</b>	300 N
<b>Nominal locking force **</b>	Max. 2600 N (2000 N ***)
<b>Service life</b>	20000 double strokes *
<b>Stroke</b>	500 mm
<b>OPEN running speed</b>	12.1 mm/s
<b>CLOSED running speed</b>	11.8 mm/s
<b>Type of protection</b>	IP 32
<b>Emission sound pressure level</b>	LpA ≤ 70 dB(A)
<b>Temperature range</b>	-15 °C (-5 °C ***) ... +75 °C
<b>Fire resistance</b>	B300 (30 min / 300 °C)
<b>Housing</b>	Aluminium
<b>Surface</b>	Powder-coated
<b>Colour</b>	White aluminium (~ RAL 9006)
<b>Connection</b>	2.5 m silicone cable
<b>Dimension A</b>	635 mm
<b>Dimension B</b>	323 mm
<b>W x H x D</b>	635 x 40 x 59 mm
<b>Weight</b>	2.1 kg
<b>Art. No.</b>	26.005.15

\* For vertical use, please consult with D+H Sales!

\*\* Depending on the mounting, \*\*\* in accordance with VdS 2580

# Dimensions

All specifications in mm

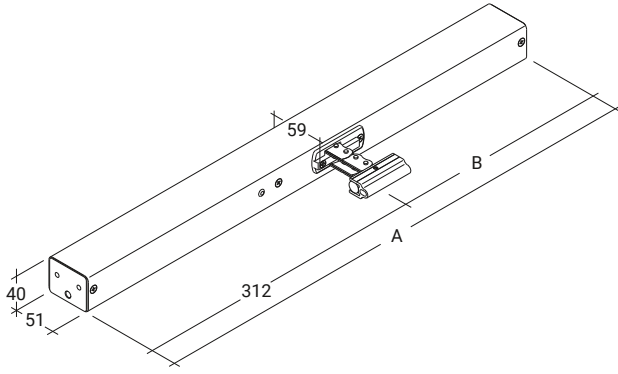

# Pressure load diagram

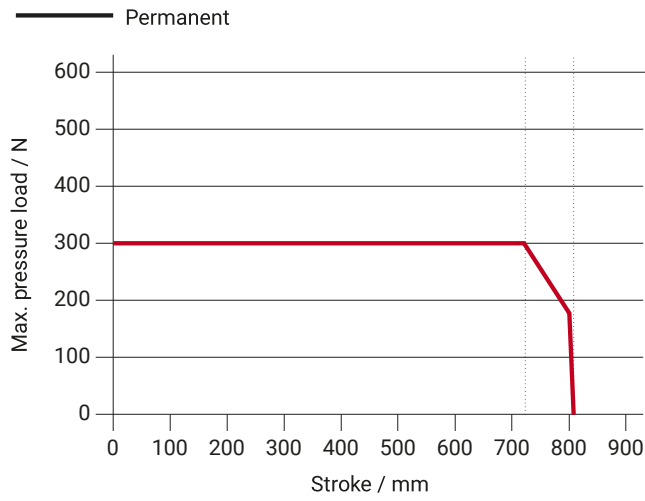

# Possible applications

- + Mounted installation
- + Frame mounting
- + Sash mounting

- + Application force
- + Application tension

