

ZA 105/500-K

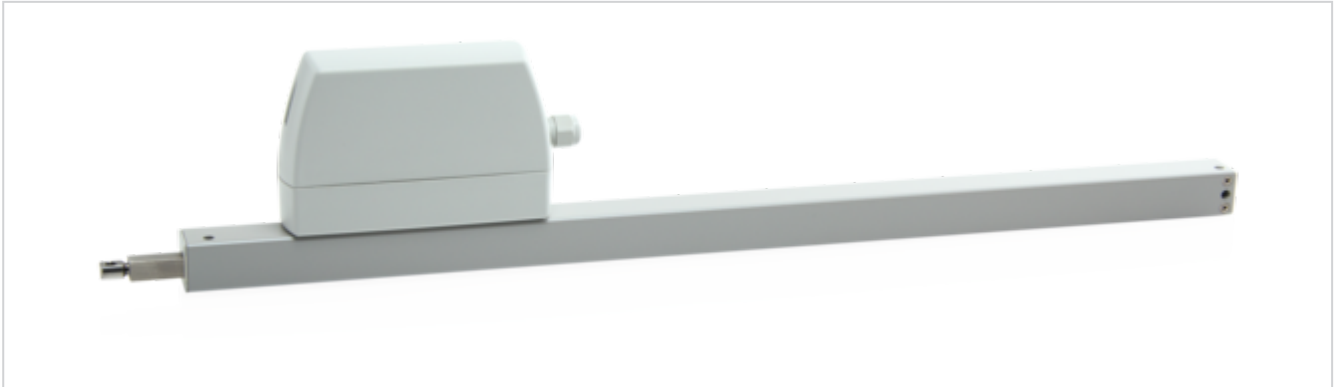

Performance features

- + Can be used for openings for smoke exhaust, D+H Euro SHEV in accordance with EN 12101-2 and for daily ventilation
- + Direct control via 230 V AC
- + Low current consumption thanks to high efficiency
- + Option of cable infeed above and below
- + Drive unit can be changed from left to right
- + Running speed in CLOSED direction decreases to 5 mm/s (passive closing edge protection)
- + Time-controlled reversing when an obstacle is detected in the CLOSED direction (active closing edge protection)

Approvals / Certificates

Details of approval on request.



5014068.16001



Technical data

ZA 105/500-K

Supply	230 V AC / +10 % ... -15 % / 50 Hz
Performance	27 W / 30 VA
Duty cycle	30 % (ON: 3 min. / OFF: 7 min.)
Force of pressure	1000 N
Tensile force	1000 N
Nominal locking force	1400 N
Service life	20000 double strokes *
Stroke	500 mm
OPEN running speed	10 mm/s
CLOSED running speed	10 mm/s
Type of protection	IP 65
Emission sound pressure level	LpA ≤ 51 dB(A)
Temperature range	-15 °C ... +75 °C
Housing	Aluminium / Polycarbonate
Surface	Powder-coated
Colour	White aluminium (~ RAL 9006)
Connection	2.5 m silicone cable
Dimension A	662 mm
Weight	1.95 kg
Art. No.	27.007.40

* For vertical use, please consult with D+H Sales!

Dimensions

All specifications in mm

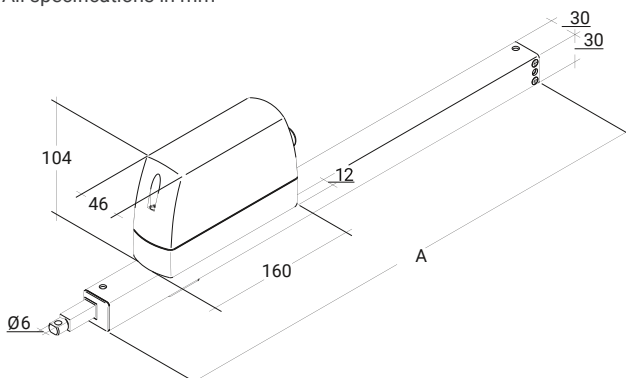

Pressure load diagram

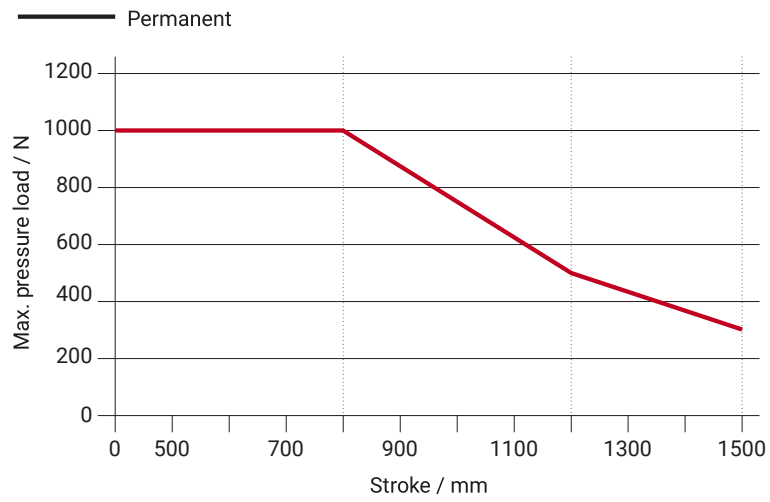

Possible applications

- + Mounted installation
- + Side installation
- + Frame mounting
- + Application force
- + Sash mounting
- + Application tension
- + Installation opposite the hinge

